

Light-Power: Gleichspannungsversorgung und Modellbahnlämpchen anschliessen

Light-Power: Connect direct current supply and model railway incandescent lamps

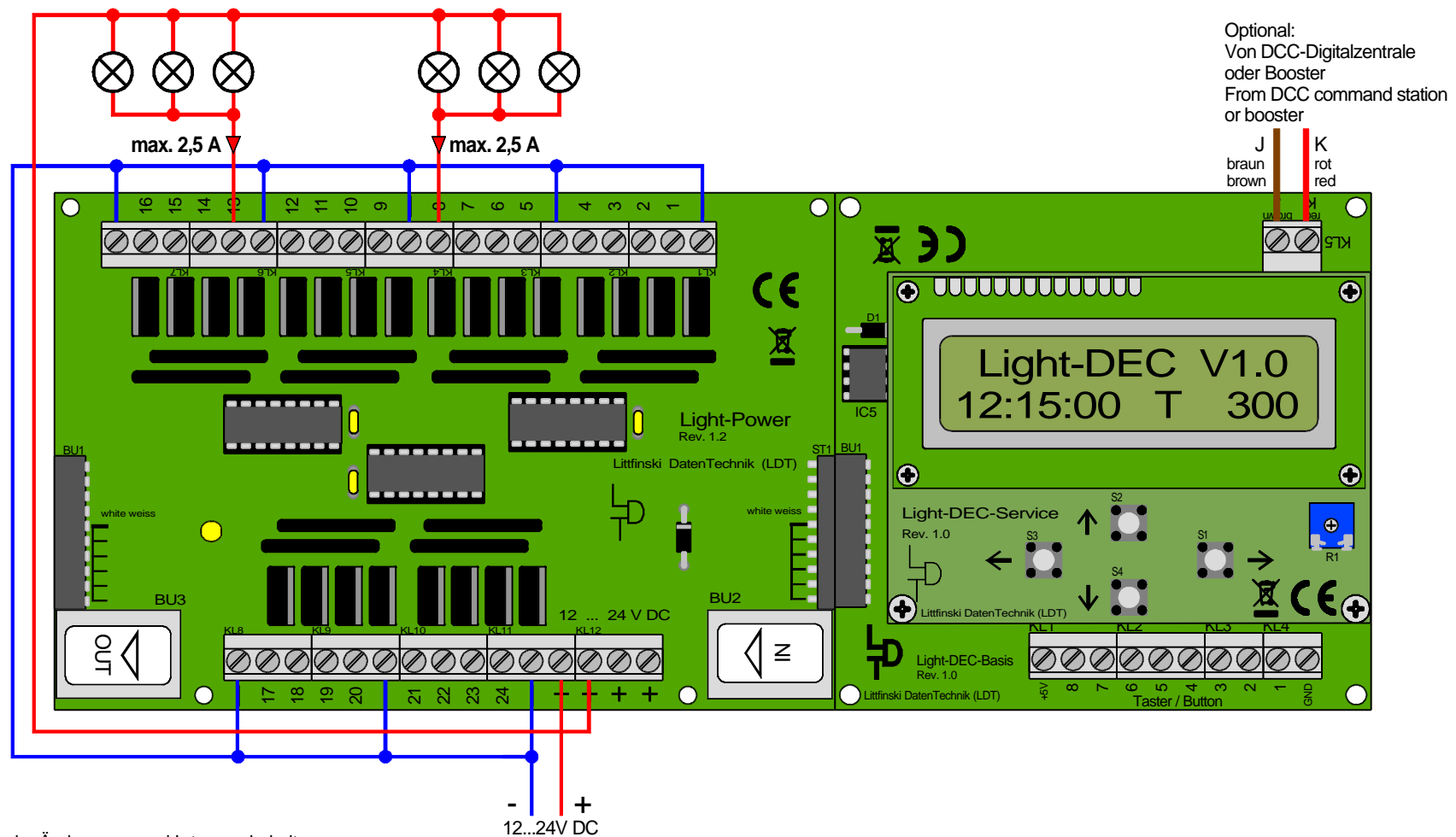

Technische Änderungen und Irrtum vorbehalten.
Subject to technical changes and errors.
© 09/2015 by LDT